

MP541

7.5...12.5 GHz Gain Block Amplifier



- frequency range 7.5...12.5 GHz
- small signal gain 20 dB
- output power (P1dB) +21 dBm
- Return loss input/output < -10 dB

Application

- telecommunications
- radars
- test and measurement equipment

The buffer amplifier MP541 is well suited for a range of microwave application and systems. This chip is manufactured using 0.25 μm pHEMT technology. The MMIC uses gold bond pads and backside metallization and are fully protected with Silicon Nitride passivation to obtain the highest level of reliability.

Electrical Specifications (Vdd1 = Vdd2 = +5 V, Vg1 = Vg2 – n.c., T = 25 °C, Idd = 85 mA)

Symbol	Parameter	Min.	Type	Max.	Unit
ΔF	Frequency range	7.5	—	12.5	GHz
G	Gain	18	—	21	dB
RL	Return loss	10	—	—	dB
NF	Noise figure at 10GHz	—	—	4.5	dB
P1dB	Output power for 1 dB compression	20.5	—	22	dBm
I	DC current	—	—	120	mA
VD	Supply voltage	—	—	8	V

Absolute maximum ratings

Parameter	Value	Unit
Supply voltage	+8	V
Operating temperature	-60...+85	°C
Storage temperature	-60...+125	°C

Typical characteristics (Vdd1 = Vdd2 = +5 V, Vg1 = Vg2 – n.c., T = 25 °C, Idd = 85 mA)

Input Return Loss

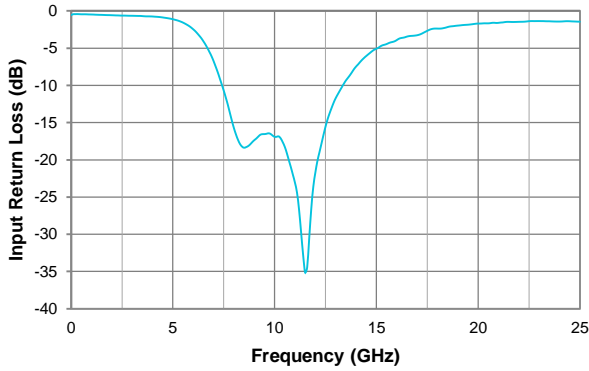

Noise Figure

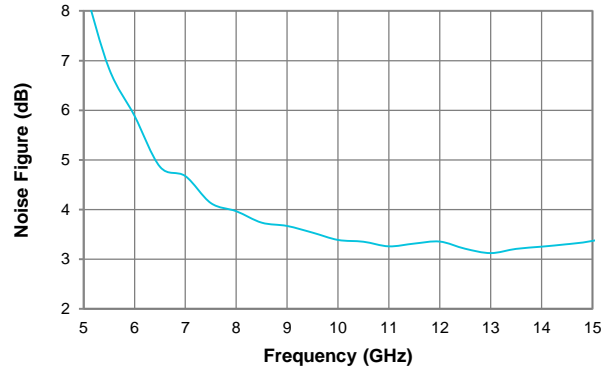

Output Return Loss

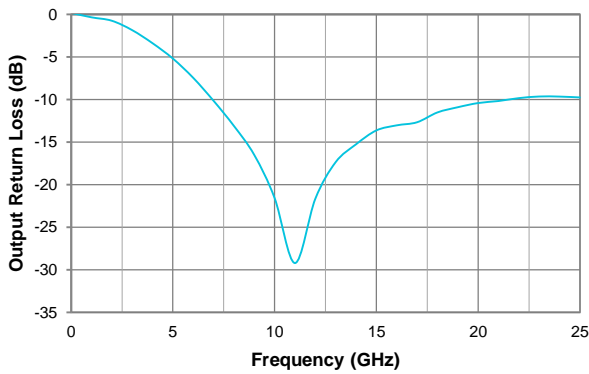

P1dB

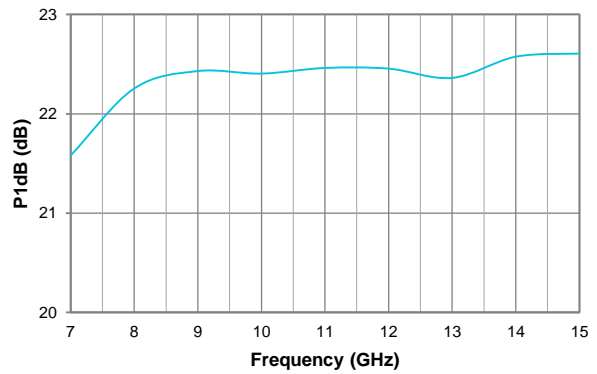

Reverse Isolation

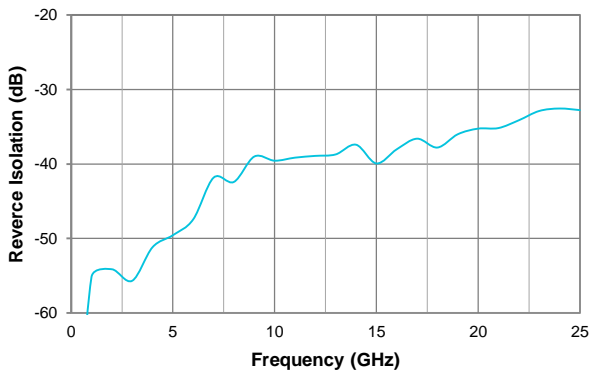

Small Signal Gain

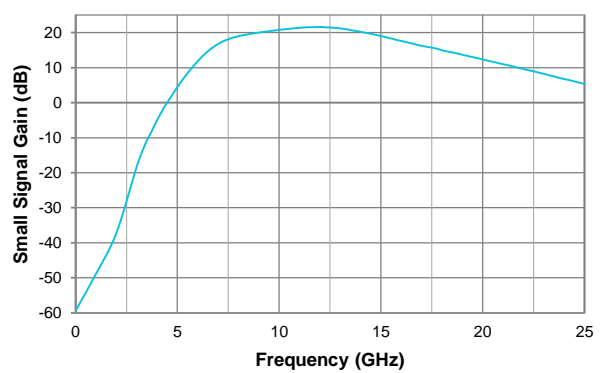

Mechanical data

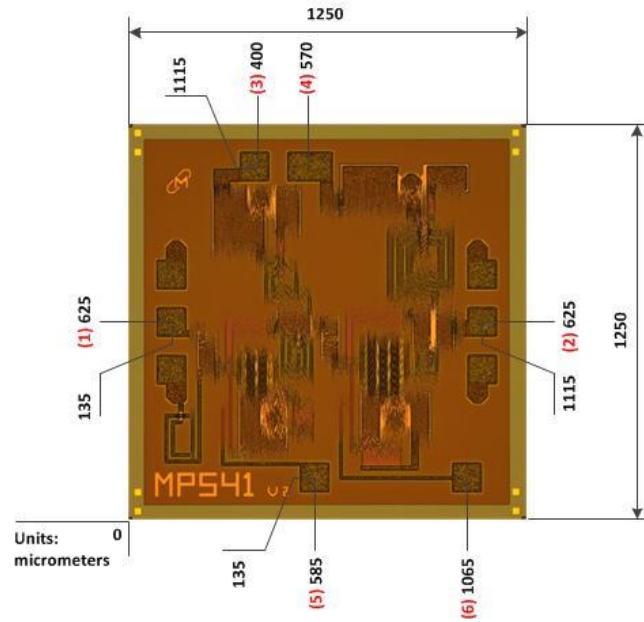

- Chip size is 1250×1250 μm (before wafer dicing), thickness is 100 μm;
- Bond pad and backside are metallized with gold;
- Pads 1-3, 5 and 6 are 100 × 100 μm, pad 4 is 150 × 100 μm.

Pad number	Pad ID	Voltage, V	Description
1	RF IN	—	RF input
2	RF OUT	—	RF output
3,4	Vdd1,Vdd2	+5	Power Supply Voltage for the amplifier
5,6	—	—	The pad is not connected

Application notes

Mounting

The chip is back-metallized and can be die mounted with AuSn eutectic alloy or with electrically conductive adhesive. The mounting surface should be clean and flat. The 50 Ohm Microstrip transmission, mounted on 0.127 mm thick alumina and thin film substrates, is recommended for bringing RF to and from the chip (Figure 1). One way to accomplish this is to attach the 0.102 mm thick die to a 0.150 mm thick molybdenum heat spreader (molytab) which is then attached to the ground plane (Figure 2). Microstrip substrates should be located as close to the die as possible in order to minimize bond wire length. Typical die-to-substrate spacing is 0.1mm.

Wire Bonding

A recommendation for RF pads (1 and 2) is one wire 25 µm in diameter and 450 µm in length. The recommendation for DC and control pads (3 and 4) is 25 µm in diameter and length 700...1000 µm.

Bias Arrangement

The device is activated by setting the pads №3 and 4 to +5V. The pads № 3 and 4 need to have DC bypass capacitances of 100pF and 0.1 µF as close to the device as possible.

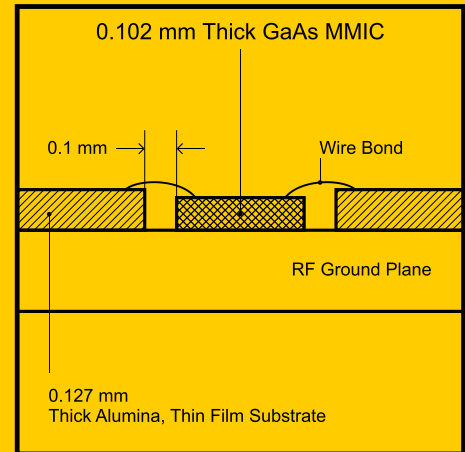

Figure 1.

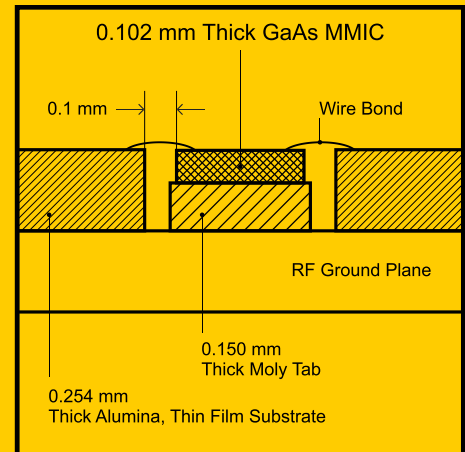

Figure 2.

Recommended ESD Management

This device is susceptible to electrostatic and mechanical damage. Dies are supplied in antistatic containers, which should be opened in cleanroom conditions at an appropriately grounded antistatic workstation. Devices need careful handling using correctly designed collets, vacuum pickups or, with care, sharp tweezers.

