

MD618

Double Balanced Mixer 4...19 GHz



- frequency range 4...19 GHz
- frequency range IF DC...4 GHz
- conversion loss <14 dB
- Isolation LO — RF 35 dB
- LO input power +15 dBm
- RF max power input $P_{IN} = +25$ dBm

Application

- telecommunications
- radars
- test and measurement equipment

The MD618 is a passive double balanced mixer based on GaAs Schottky diode technology. It is ideally suited for applications where small size is needed. RF and LO frequencies range from 4 to 19 GHz, IF frequency range goes from DC to 4 GHz. This mixer can operate at a +15 dBm LO drive level with a conversion loss less than 14 dB. The MD618 is compatible with conventional die attach methods, which makes it ideal for MCM and hybrid-integrated microwave modules with general sealing.

Electrical specification (T = 25 °C)

Symbol	Parameter	Min.	Type	Max.	Min.	Type	Max.	Unit
$\Delta F_{LO}, \Delta F_{RF}$	Frequency range LO and RF	4...10			10...19			GHz
ΔF_{IF}	Frequency range IF	DC...4						GHz
CL	Conversion loss	—	8	10	—	9	12	dB
ISO_{LO-RF}	LO to RF Isolation	35	40	—	—	38	—	dB
ISO_{LO-IF}	LO to IF Isolation	20 (A); 35 (B)	25 (A); 40 (B)	—	25 (A); 40 (B)	28 (A); 45 (B)	—	dB
ISO_{RF-IF}	RF to IF Isolation	35 (A); 20 (B)	40 (A); 25 (B)	—	40 (A); 25 (B)	45 (A); 28 (B)	—	dB
IIP3	Input IP3	12 (A); 3 (B)	15 (A); 12 (B)	—	18 (A); 20 (B)	22	—	dB
P1dB	1 dB Gain compression (input)	—	10	—	—	12	—	dBm
P_{MAX}	RF max power input	+25						dBm

NOTE All measurements performed with LO input power $P_{LO} = +15$ dBm

Circuit diagram

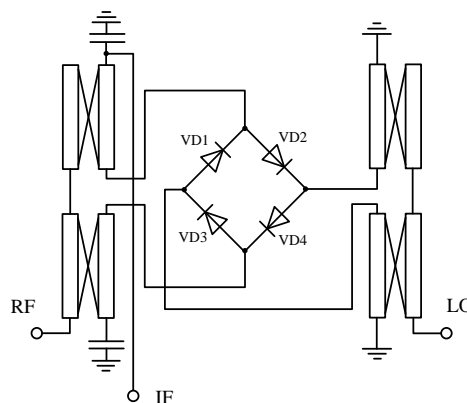

Functional block diagram

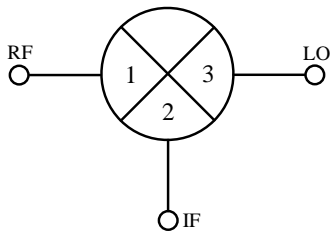

Configuration A

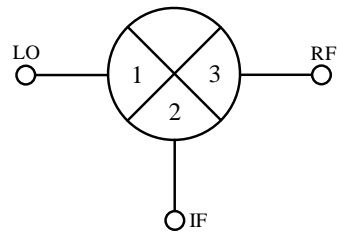

Configuration B

Typical characteristics (T = 25 °C)

Conversion Loss (config. A)

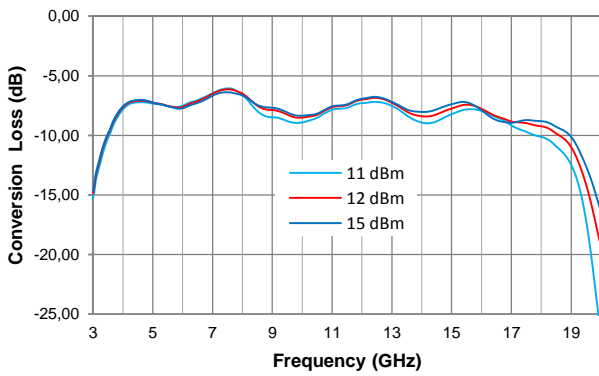

Conversion Loss (config. B)

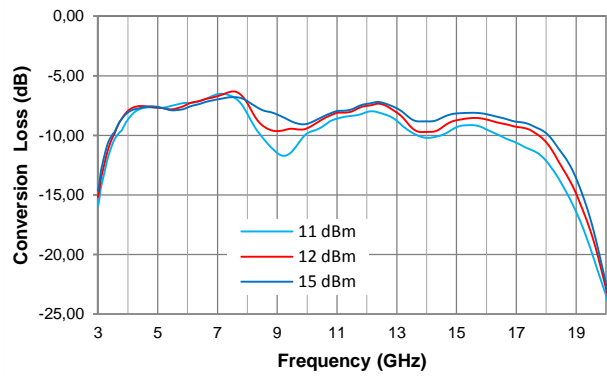

Return Loss (config. A)

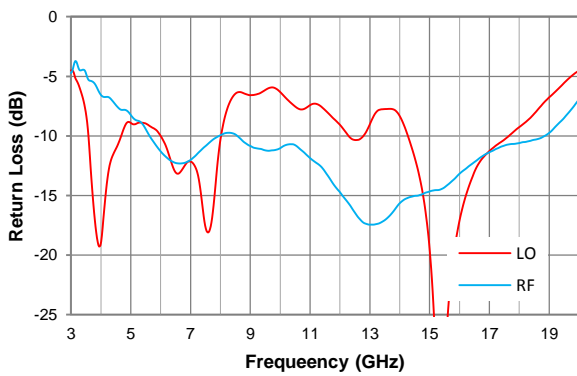

Return Loss (config. B)

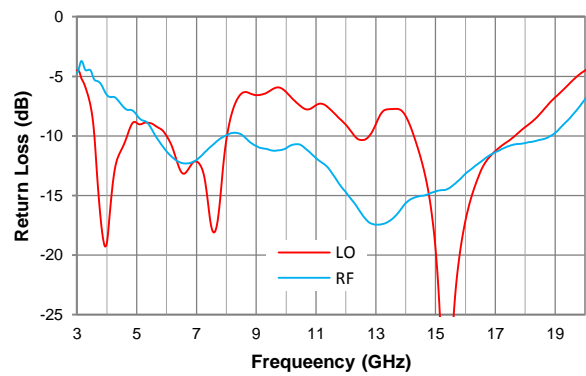

Specifications are subject to change without notice.

IIP3 (config. A)

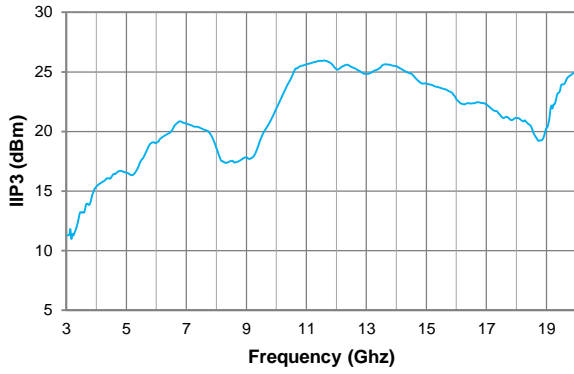

IIP3 (config. B)

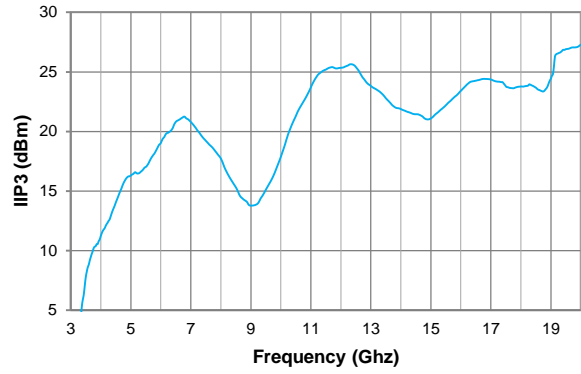

Isolation (config. A), PLO = 15 dBm,

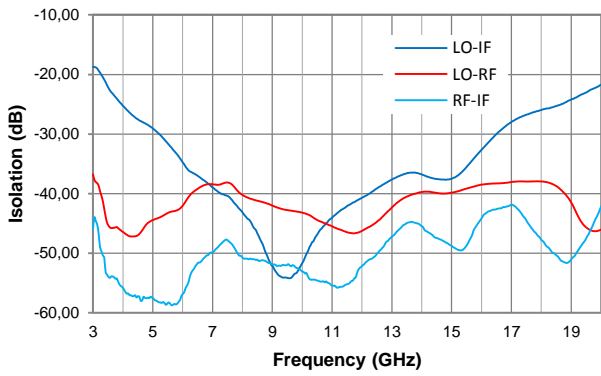

Isolation (config. B), PLO = 15 dBm,

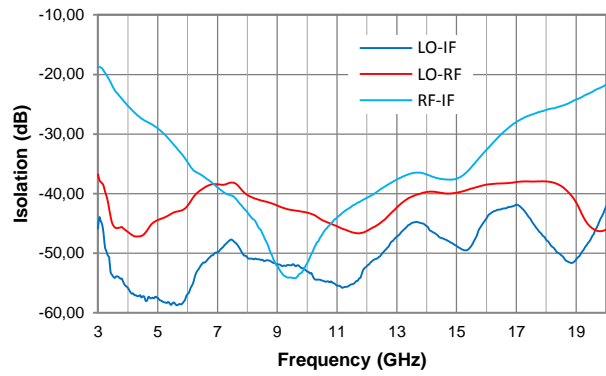

Mechanical data

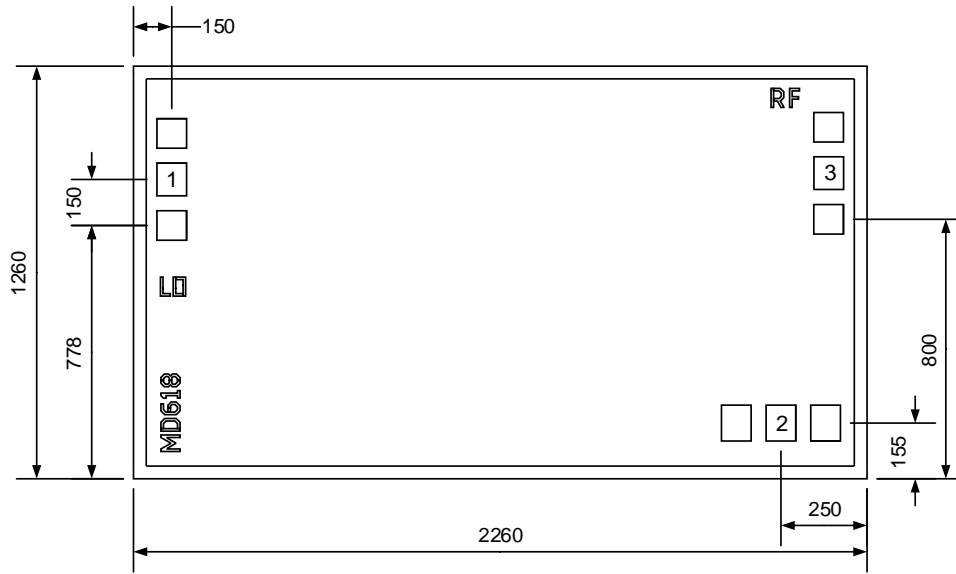

- Chip size 1 260 × 2 260 μm (before wafer dicing), thickness 100 μm.
- Position coordinates are shown for the bond pad center.
- Bond pad and backside are metallized with gold.
- Pads are 150 × 100 μm.

Pad number	Pad ID	Description
1	LO	LO input
2	IF	IF input / output
3	RF	RF input / output

Application notes

Mounting

The chip is back-metallized with gold and can be die mounted with AuSn eutectic alloy or with electrically conductive adhesive. The mounting surface should be clean and flat. The 50 Ohm Microstrip transmission, mounted on 0.127mm thick alumina and thin film substrates, is recommended for bringing RF to and from the chip (Figure 1). One way to accomplish this is to attach the 0.102 mm thick die to a 0.150 mm thick molybdenum heat spreader (molytab) which is then attached to the ground plane (Figure 2). Microstrip substrates should be located as close to the die as possible in order to minimize bond wire length. Typical die-to-substrate spacing is 0.1mm.

Wire Bonding

It is recommended for RF pads to use a wire 25 µm in diameter and 300 µm in length.

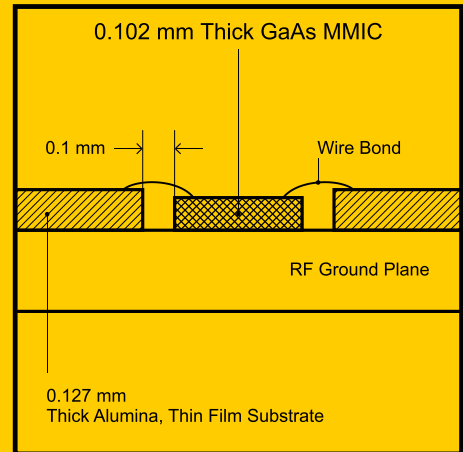

Figure 1.

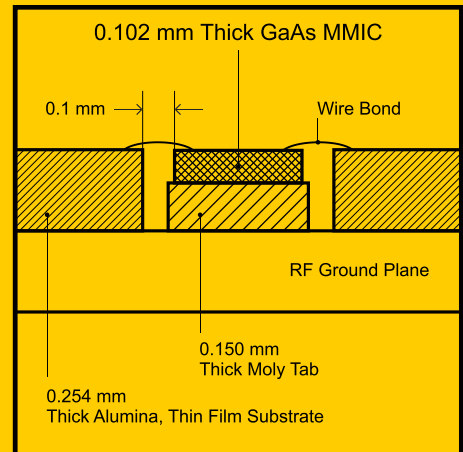

Figure 2.

Recommended ESD Management

This device is susceptible to electrostatic and mechanical damage. Dies are supplied in antistatic containers, which must be opened in cleanroom conditions at an appropriately grounded antistatic workstation. Devices need careful handling using correctly designed collets, vacuum pickups or, with care, sharp tweezers.

